

5. Attention:

- 5.1 The product shall be installed and serviced by the qualified person.
- 5.2 This product is non-waterproof. Please avoid the sun and rain. When installed outdoors, please ensure it is mounted in a water proof enclosure.
- 5.3 Good heat dissipation will prolong the working life of the controller. Please ensure good ventilation.
- 5.4 Please check if the output voltage of the LED power supply used comply with the working voltage of the product.
- 5.5 Please ensure that adequate sized cable is used from the controller to the LED lights to carry the current. Please also ensure that the cable is secured tightly in the connector.
- 5.6 Ensure all wire connections and polarities are correct before applying power to avoid any damages to the LED lights.
- 5.7 If a fault occurs, please return the product to your supplier. Do not attempt to fix this product by yourself.

6. Warranty Agreement:

- 6.1 We provide lifelong technical assistance with this product:
 - A 5-year warranty is given from the date of purchase. The warranty is for free repair or replacement if cover manufacturing faults only.
 - For faults beyond the 5-year warranty, we reserve the right to charge for time and parts.
- 6.2 Warranty exclusions below:
 - Any man-made damages caused from improper operation, or connecting to excess voltage and overloading.
 - The product appears to have excessive physical damage.
 - Damage due to natural disasters and force majeure.
 - Warranty label, fragile label and unique barcode label have been damaged.
 - The product has been replaced by a brand new product.
- 6.3 Repair or replacement as provided under this warranty is the exclusive remedy to the customer. we shall not be liable for any incidental or consequential damages for breach of any stipulation in this warranty.
- 6.4 Any amendment or adjustment to this warranty must be approved in writing by our company only.
 - ★This manual only applies to this model. We reserve the right to make changes without prior notice.

LT-391-10A 0/1-10V LED Dimming Driver (Constant Voltage)



Along with the rise of LED illumination, LED lamps are widely used in hotel, business center, household decoration, etc. There are more and more chances to use LED and fluorescent lights at the same project, if LED lamps and fluorescent lights can be controlled together by a traditional fluorescent dimming system, it will make everything more convenient, but the dimming principles of LED and traditional fluorescent lights are different, LED lights can not be dimmed by the fluorescent dimming controller directly.

As a fact of that, our company developed a new 0/1-10V to PWM dimming driver which has solved the compatible problem of fluorescent dimming system and LED illumination, therefore LED lamps can be controlled by many traditional intelligent dimming system.

1. Technical Specs:

LT-391-10A 0/1-10V LED Dimming Driver

Input Signal:	0/1-10V	Working Temperature:	-30°C~55°C
Output Signal:	PWM	Dimensions:	L121×W39×H39(mm)
Input Voltage:	12-24Vdc	Package Size:	L123×W42×H42(mm)
Max Current Load:	10A × 1CH Max 10A	Weight[G.W.]:	90g
Max Output Power:	120W/240W(12V/24V)		
Dimming Range:	0~100%		

2. Product Size:

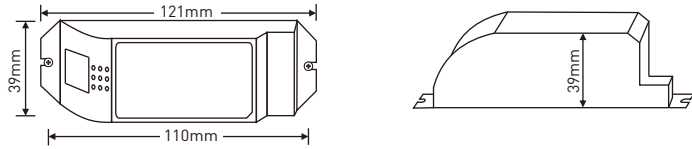

3. Terminal Description:

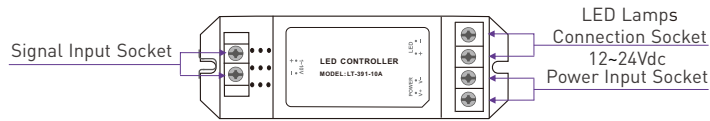

4. Wiring Diagram:

4.1 Connection diagram for single unit :

Example 1: 12V lamp connected, loads 0~120W(12V).

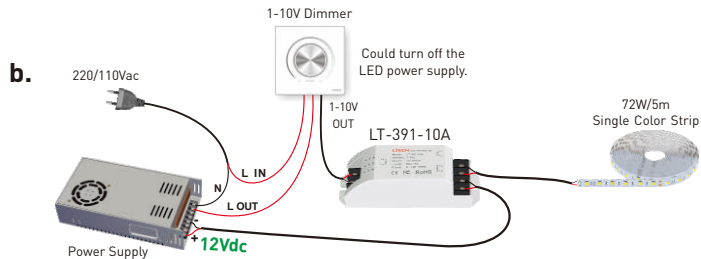
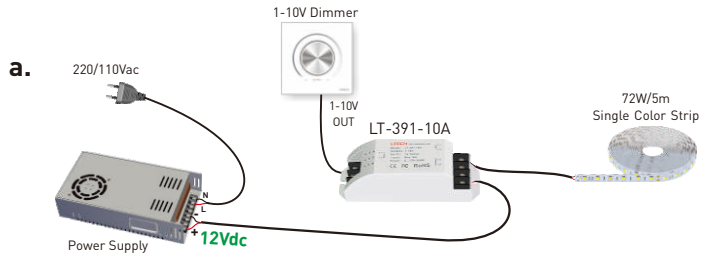

2

Example 2: 24V lamp connected, loads 0~240W(24V).

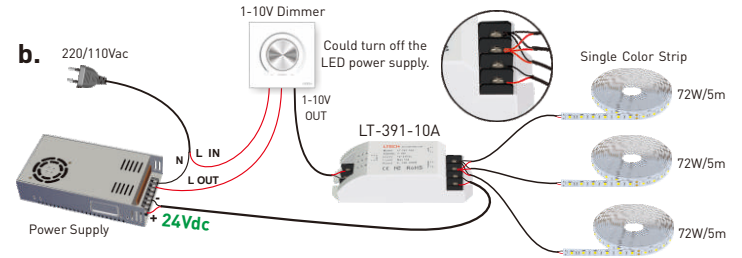
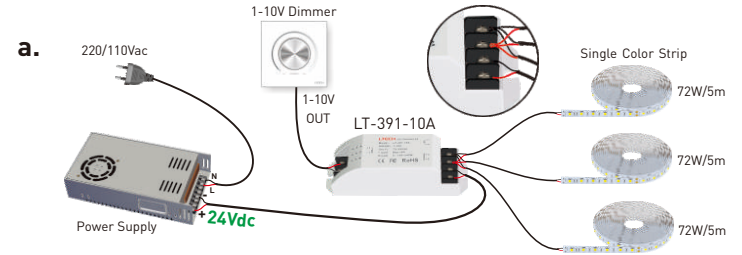

4.2 System Connection Diagram:

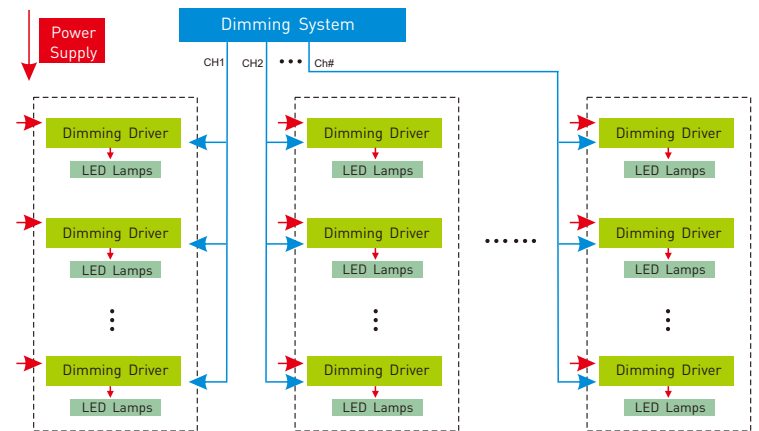

3